



**Item type**  
Dining chair

**Item name**  
Cliff set of 2

**Item no**  
113784

**Attention!** Place the item on a soft material on the floor before starting with the assembly, to prevent the item from being damaged.

**Care instructions:**

Vacuum clean the upholstery regularly with low power. Remove spills and stains a.s.a.p. but never with harsh soaps or detergents.

**Eichholtz B.V.**  
Delfweg 52  
2211 VN Noordwijkerhout  
The Netherlands

🏠 [www.eichholtz.com](http://www.eichholtz.com)  
✉ [service@eichholtz.com](mailto:service@eichholtz.com)  
☎ +31 (0)252 515 850

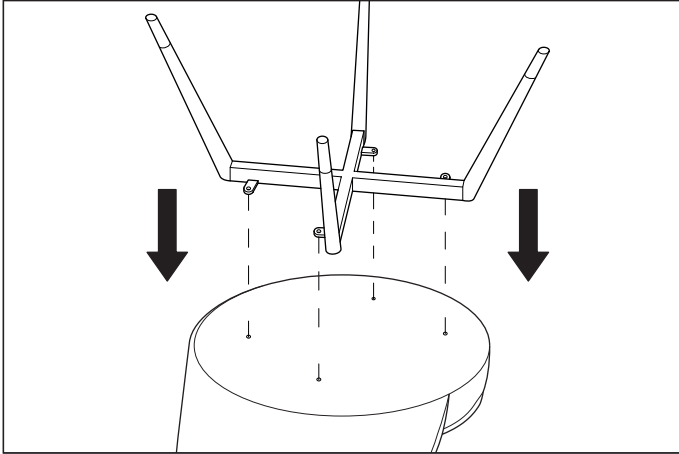

1. Align the frame of the legs with the screw holes on the base of the chair.

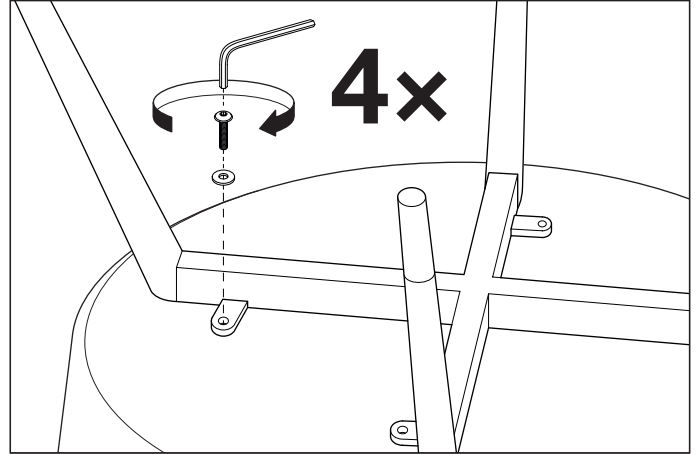

2. Fix the frame to the base using the allen screws combined with the metal rings. Secure the screws tightly before using the chair.