



E I C H H O L T Z

112549 COFFEE TABLE PARME OVAL

ASSEMBLY INSTRUCTION

PARTS

1x

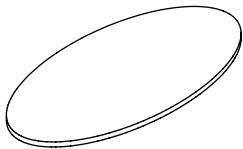

(A)

1x

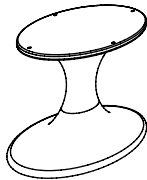

(B)

1x

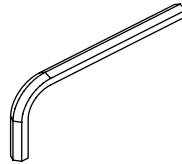

(C)

4x



(D)

4x

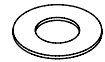

(E)

1

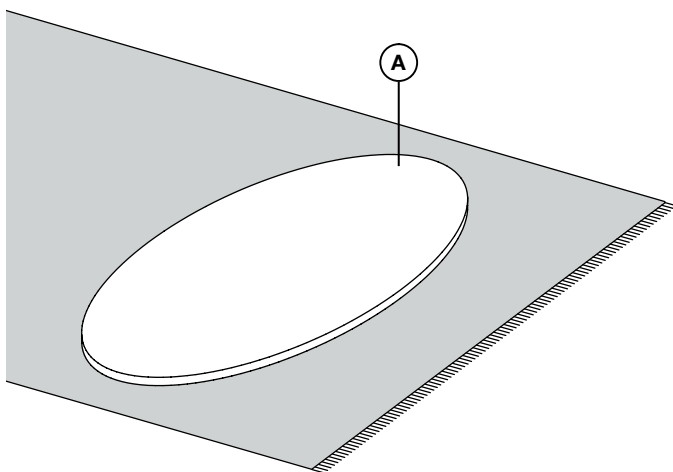

2

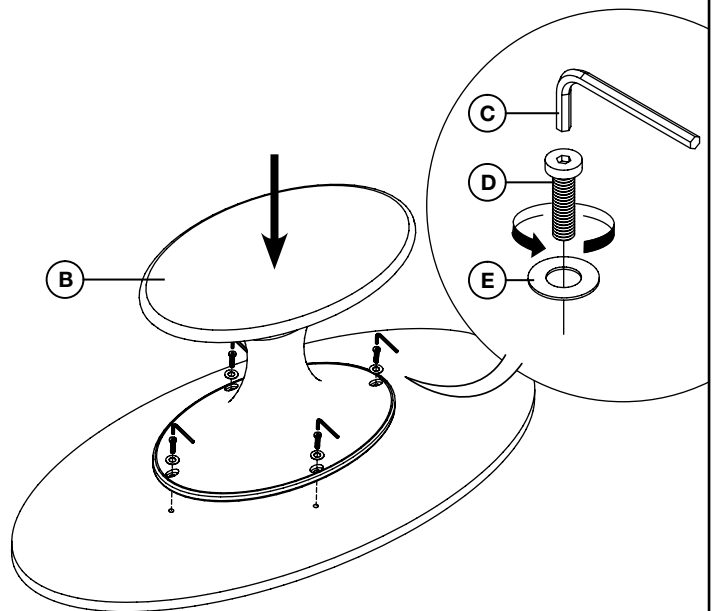

3

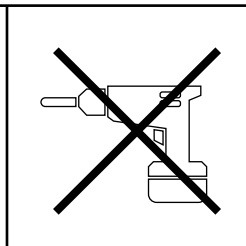

FINAL

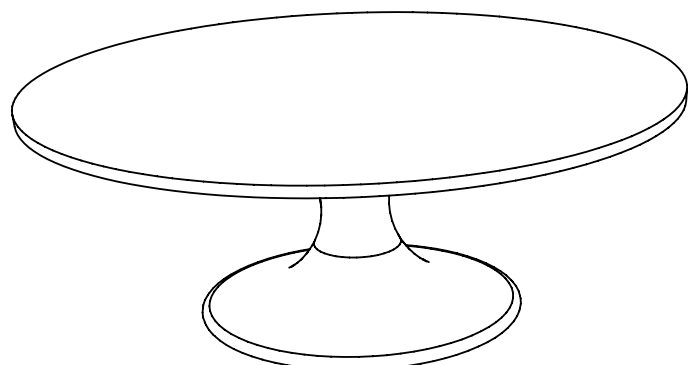

- 1: Put the table top (A) on a carpeted floor.
- 2: Fix the table top (A) to the base (B) with the four screws (D) and the rings (E) using the allen key (C).

Do not use power tools!

CARE INSTRUCTION

Wipe clean with soft, dry cloth.
Always avoid the use of harsh chemicals or abrasive cleaners as they may cause damage to the fixture's finish.