



E I C H H O L T Z

112049 COFFEE TABLE PARME OVAL

ASSEMBLY INSTRUCTION

**PARTS**

1x

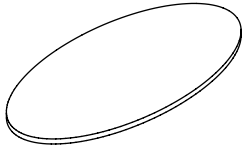

(A)

1x

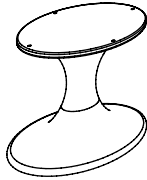

(B)

1x

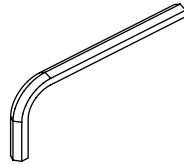

(C)

4x



(D)

4x

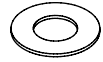

(E)

1

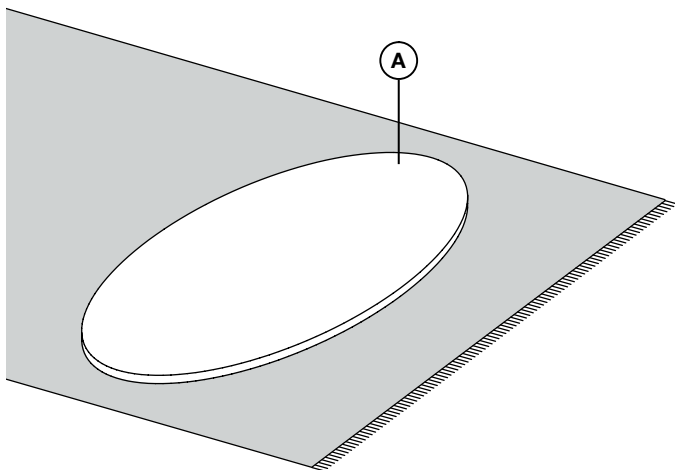

2

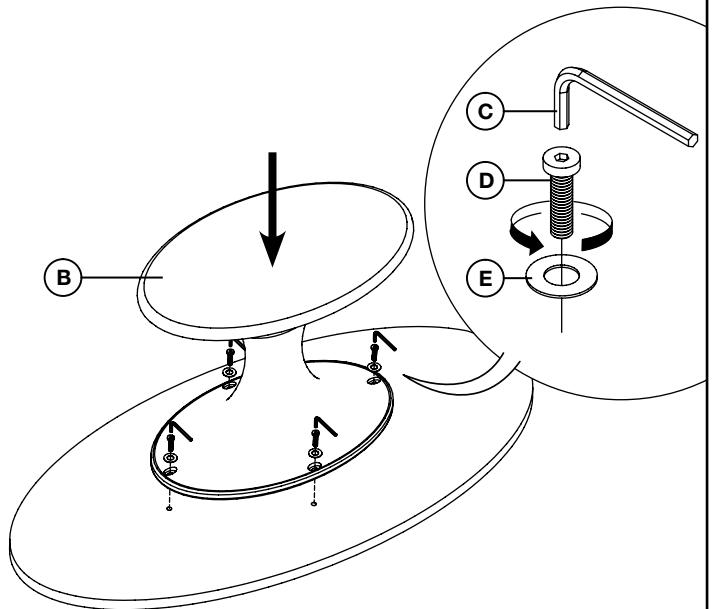

3

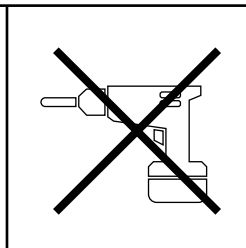

**FINAL**

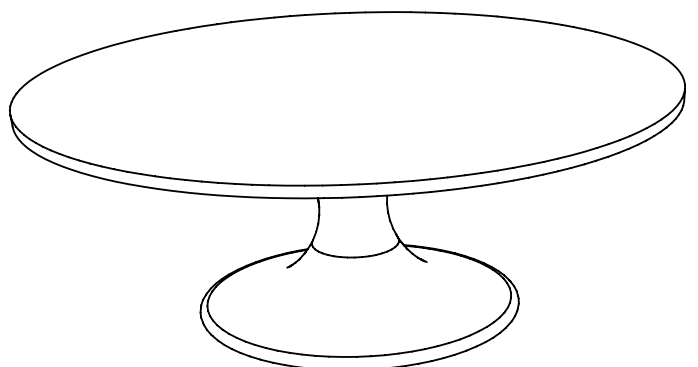

- 1: Put the table top (A) on a carpeted floor.
- 2: Fix the table top (A) to the base (B) with the four screws (D) and the rings (E) using the allen key (C).

Do not use power tools!

**CARE INSTRUCTION**

Wipe clean with soft, dry cloth.  
Always avoid the use of harsh chemicals or abrasive cleaners as they may cause damage to the fixture's finish.