

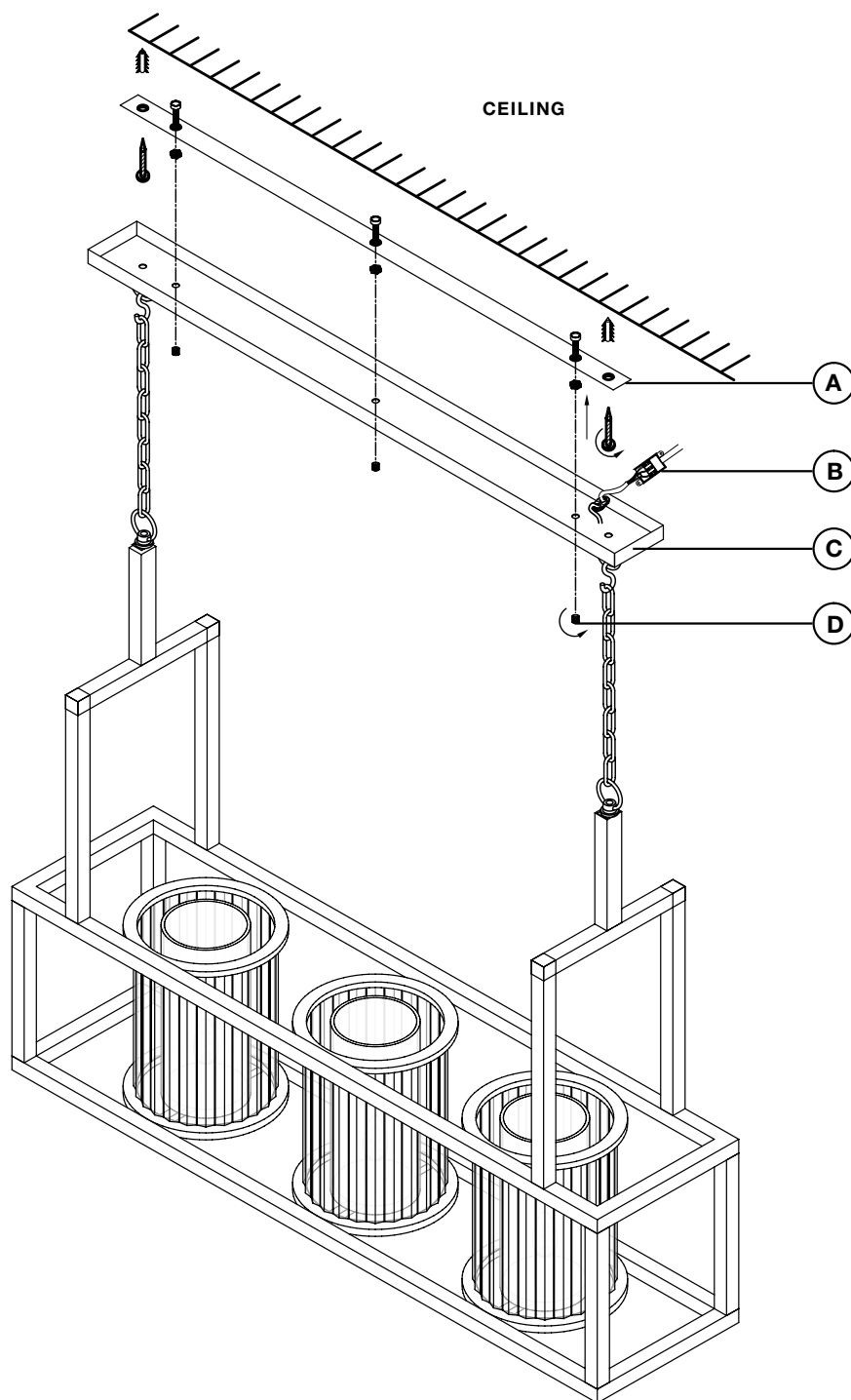

E I C H H O L T Z

111106 CHANDELIER CARDUCCI

ASSEMBLY INSTRUCTION



Turn off the electricity supply at the main circuit panel before installing.
Do not connect the electricity supply until your luminaire is fully assembled and installed.

Fix the ceiling plate (A) to the ceiling by using mounting plugs and screws suitable to your ceiling type.

Place the luminaire in an elevated position in such a way that the wires can freely reach the ceiling junction box.

Thread the wires through the components and connect the 3 power wires according to their colours (B). Brown is the live wire, blue is the neutral wire, green/yellow is the earth wire.

Place the ceiling canopy (C) over the ceiling bracket and fix it securely with the 3 nuts supplied (D).

Hang the luminaire from the ceiling canopy with chains.